

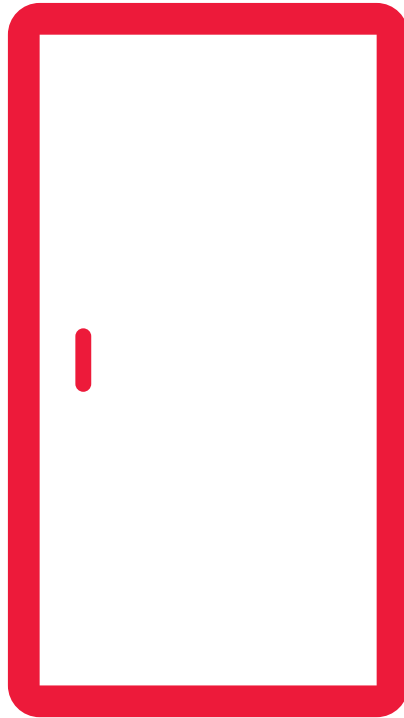

## Freezer

EN User Manual







Single Door

SJ-SC41CHXI2-EN  
SJ-SC41CHXW2-EN

**Thank you for choosing this product.**

This user manual contains important information on safety and instructions intended to assist you in the operation and maintenance of your appliance.

Please take the time to read this user manual before using your appliance and keep this book for future reference.

Icon	Type	Meaning
	<b>WARNING</b>	Serious injury or death risk
	<b>RISK OF ELECTRIC SHOCK</b>	Dangerous voltage risk
	<b>FIRE</b>	Fire risk
	<b>CAUTION</b>	Injury or property damage risk
	<b>IMPORTANT</b>	Operating the system correctly

# Contents

<b>CHAPTER -1: GENERAL WARNINGS .....</b>	<b>3</b>
<b>CHAPTER -2: YOUR FREEZER.....</b>	<b>7</b>
<b>CHAPTER -3: USING YOUR FREEZER .....</b>	<b>8</b>
<b>CHAPTER -4: FOOD STORAGE GUIDANCE .....</b>	<b>11</b>
<b>CHAPTER -5: DOOR REVERSAL .....</b>	<b>11</b>
<b>CHAPTER -6: TROUBLESHOOTING .....</b>	<b>12</b>
<b>CHAPTER -7: TIPS FOR SAVING ENERGY .....</b>	<b>14</b>
<b>CHAPTER -8: SERVICE &amp; WARRANTY.....</b>	<b>14</b>

Your freezer conforms to current safety requirements. Inappropriate use can lead to personal injury and damage to property. To avoid the risk of damage read this manual carefully before using your freezer for the first time. It contains important safety information on the installation, safety, use and maintenance of your Freezer. Retain this manual for future use.

## CHAPTER -1: GENERAL WARNINGS

### Read this user manual carefully.



**WARNING:** Keep ventilation openings, in the appliance enclosure or in the built-in structure, clear of obstruction.



**WARNING:** Do not use mechanical devices or other means to accelerate the defrosting process, other than those recommended by the manufacturer.



**WARNING:** Do not use electrical appliances inside the food storage compartments of the appliance, unless they are of the type recommended by the manufacturer.



**WARNING:** Do not damage the refrigerant circuit.



**WARNING:** In order to avoid any hazards resulting from the instability of the appliance, it must be fixed in accordance with the following instructions:



If your appliance uses R600a as a refrigerant (this information will be provided on the label of the cooler) you should take care during transportation and installation to prevent the cooler elements from being damaged. R600a is an environmentally friendly and natural gas, but it is explosive. In the event of a leak due to damage of the cooler elements, move your fridge away from open flames or heat sources and ventilate the room where the appliance is located for a few minutes.

- While carrying and positioning the fridge, do not damage the cooler gas circuit.
- Do not store explosive substances such as aerosol cans with a flammable propellant in this appliance.
- This appliance is intended to be used in household and domestic applications such as:
  - staff kitchen areas in shops, offices and other working environments.
  - farm houses and by clients in hotels, motels and other residential type environments.
  - bed and breakfast type environments;
  - catering and similar non-retail applications.
- If the socket does not match the refrigerator plug, it must be replaced by the manufacturer, a service agent or similarly

## CHAPTER -1: GENERAL WARNINGS

qualified persons in order to avoid a hazard.

- A specially grounded plug has been connected to the power cable of your refrigerator. This plug should be used with a specially grounded socket of 16 amperes. If there is no such socket in your house, please have one installed by an authorised electrician.
- This appliance can be used by children aged from 8 years and above and persons with reduced physical, sensory or mental capabilities or lack of experience and knowledge if they have been given supervision or instruction concerning use of the appliance in a safe way and understand the hazards involved. Children shall not play with the appliance. Cleaning and user maintenance shall not be made by children without supervision.
- If the supply cord is damaged, it must be replaced by the manufacturer, an authorised service agent or similar qualified persons, in order to avoid a hazard.
- This appliance is not intended for use at altitudes exceeding 2000 m.

# CHAPTER -1: GENERAL WARNINGS

## Installation warnings

Before using your freezer for the first time, please pay attention to the following points:

- The operating voltage for your freezer is 220-240 V at 50Hz.
- The plug must be accessible after installation.
- Your freezer may have an odour when it is operated for the first time. This is normal and the odour will fade when your freezer starts to cool.
- Before connecting your freezer, ensure that the information on the data plate (voltage and connected load) matches that of the mains electricity supply. If in doubt, consult a qualified electrician.
- Insert the plug into a socket with an efficient ground connection. If the socket has no ground contact or the plug does not match, we recommend you consult a qualified electrician for assistance.
- The appliance must be connected with a properly installed fused socket. The power supply (AC) and voltage at the operating point must match with the details on the name plate of the appliance (the name plate is located on the inside left of the appliance).
- We do not accept responsibility for any damages that occur due to ungrounded usage.
- Place your freezer where it will not be exposed to direct sunlight.
- Your freezer must never be used outdoors or exposed to rain.
- Your appliance must be at least 50 cm away from stoves, gas ovens and heater cores, and at least 5 cm away from electrical ovens.
- If your freezer is placed next to a deep freezer, there must be at least 2 cm between them to prevent humidity forming on the outer surface.
- Do not cover the body or top of fridge with lace. This will affect the performance of your freezer.
- Clearance of at least 150 mm is required at the top of your appliance. Do not place anything on top of your appliance.
- Do not place heavy items on the appliance.
- Clean the appliance thoroughly before use (see Cleaning and Maintenance).
- The installation procedure into a kitchen unit is given in the installation manual. This product is intended to be used in proper kitchen units only.
- Before using your freezer, wipe all parts with a solution of warm water and a teaspoon of sodium bicarbonate. Then, rinse with clean water and dry. Return all parts to the freezer after cleaning. Important installation instructions

This appliance is designed to work in difficult climate conditions (up to 43 degrees C or 110 degrees F) and is powered with 'Freezer Shield' technology which ensures that the frozen food in the freezer will not defrost even if the ambient temperature falls as low as -15 °C. So you may then install your appliance in an unheated room without having to worry about frozen food in the freezer being spoilt. When the ambient temperature returns to normal, you may continue using the appliance as usual.

- Use the adjustable front legs to make sure your appliance is level and stable. You can adjust the legs by turning them in either direction. This must be done before placing food in the appliance.
- Install the two plastic distance guides (the parts on the black vanes -condenser- at the rear) by turning it 90° (as shown in the figure) to prevent the condenser from touching the wall.
- The distance between the appliance and back wall must be a minimum of 75 mm.

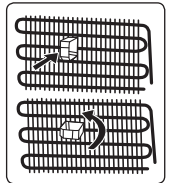

## Electrical connection (For UK type plug)

For your safety please read the following information

**Warning:** This appliance must be earthed.

This appliance operates from 220-240 volts and should be protected by a 13 amp fuse in the plug.

The appliance is supplied with a standard 13 amp 3-pin mains plug fitted with a 13-amp fuse. Should the fuse require replacement, it must be replaced with a fuse rated at 13 amp and approved to BS1362.

If the mains plug which is fitted is unsuitable for the socket outlet in your home or is removed for any other reason, please follow the instructions below on how to wire a 13 amp 3 pin plug..

### How to wire a 13 amp plug?



The wires in the mains lead on this appliance are coloured in accordance with the following code:

**Green and Yellow** - Earth

**Blue** – Neutral

**Brown** – Live

As the colours may not correspond with the markings identifying the terminals in your plug proceed as follows.

The green and yellow wire must be connected to the terminal in the plug which is marked with the letter E or with the earth symbol or coloured green and yellow.

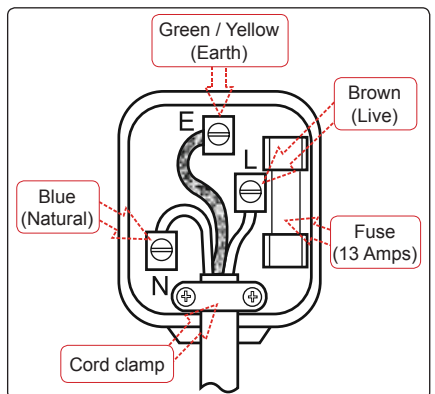

## CHAPTER -1: GENERAL WARNINGS

The blue wire must be connected to the terminal marked N.  
The brown wire must be connected to the terminal marked L.  
You must make sure the lead is firmly secured under the cord clamp.

### During Usage

- Do not connect your freezer to the mains electricity supply using an extension lead.
- Do not use damaged, torn or old plugs.
- Do not pull, bend or damage the cord.
- This appliance is designed for use by adults. Do not allow children to play with the appliance or hang off the door.
- Never touch the power cord/plug with wet hands. This may cause a short circuit or electric shock.
- Do not place glass bottles or cans in your freezer as they will burst when the contents freeze.
- Do not place explosive or flammable material in your freezer.
- When removing ice from the ice-making compartment, do not touch it. Ice may cause frost burns and/or cuts.
- Do not touch frozen goods with wet hands. Do not eat ice-cream or ice cubes immediately after they are removed from the ice-making compartment.
- Do not re-freeze thawed frozen food. This may cause health issues such as food poisoning.

When the door of the freezer is closed, a vacuum seal will form. Wait for 1 minute before reopening it.

This application is optional for easy opening of the door. With this application, a little condensation may occur around this area and you may remove it.

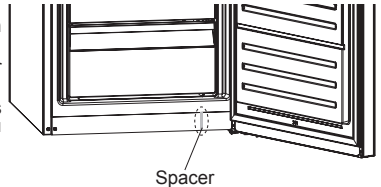

### Old and Out-of-order Fridges

- If your old fridge or freezer has a lock, break or remove the lock before discarding it, because children may get trapped inside it and may cause an accident.
- Old fridges and freezers contain isolation material and refrigerant with CFC. Therefore, take care not to harm environment when you are discarding your old fridges.

### CE Declaration of conformity

We declare that our products meet the applicable European Directives, Decisions and Regulations and the requirements listed in the standards referenced.

### Disposal of your old appliance

The symbol on the product or on its packaging indicates that this product may not be treated as household waste. Instead it shall be handed over to the applicable collection point for the recycling of electrical and electronic equipment. By ensuring this product is disposed of correctly, you will help prevent potential negative consequences for the environment and human health, which could otherwise be caused by inappropriate waste handling of this product. For more detailed information about recycling of this product, please contact your local city office, your household waste disposal service or the shop where you purchased the product.



### Packaging and the Environment

Packaging materials protect your machine from damage that may occur during transportation. The packaging materials are environmentally friendly as they are recyclable. The use of recycled material reduces raw material consumption and therefore decreases waste production.

### Notes:

- Please read the instruction manual carefully before installing and using your appliance. We are not responsible for the damage occurred due to misuse.
- Follow all instructions on your appliance and instruction manual, and keep this manual in a safe place to resolve the problems that may occur in the future.
- This appliance is produced to be used in homes and it can only be used in domestic environments and for the specified purposes. It is not suitable for commercial or common use. Such use will cause the guarantee of the appliance to be cancelled and our company will not be responsible for the losses to be occurred.
- This appliance is produced to be used in houses and it is only suitable for cooling / storing foods. It is not suitable for commercial or common use and/or for storing substances except for food. Our company is not responsible for the losses to be occurred in the contrary case.

## CHAPTER -1: GENERAL WARNINGS

### No-Frost technology

Your freezer differs from many other standard freezers. Other appliances may experience ice in the freezer due to the opening of the door and humidity caused by the food. In such appliances defrosting is required. They have to be turned off periodically, the food inside moved and the ice removed.

Your "no frost" freezer prevents such problems by evenly distributing in the freezer through the use of a fan. This cools your food evenly and uniformly, preventing humidity and freezing.

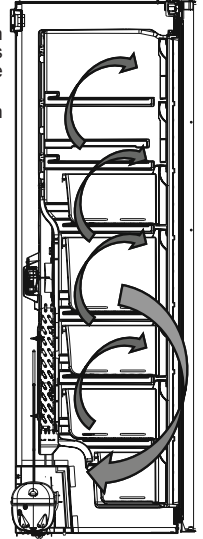

## CHAPTER -2: YOUR FREEZER

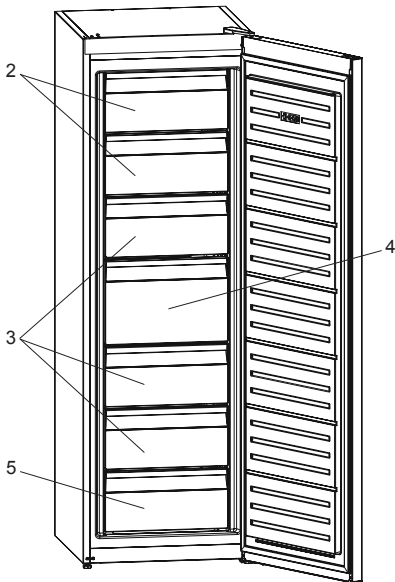

In some models there is a shelf with icematic in the top basket.

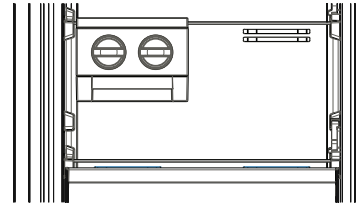

1. Ice tray \* / Ice matic \*
2. Freezer flap
3. Freezer drawers
4. Freezer big drawer
5. Freezer bottom drawer

\* In some models

This figure has been drawn for information purposes to show the various parts and accessories in the appliance. Parts may vary according to the model of the appliance.



## CHAPTER -3: USING YOUR FREEZER

### Display and control panel

#### Using the Control Panel

1. Freezer temperature setting.
2. Super Freeze mode indicator
3. Eco mode indicator
4. Alarm indicator
5. Child Lock mode indicator
6. Mode Selector
7. Decrease value
8. Increase value
9. Child Lock Selector

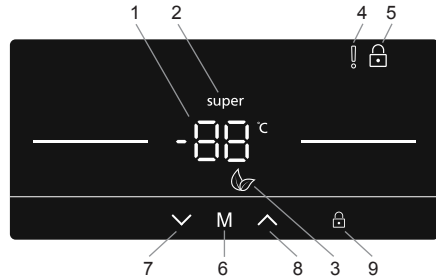

### Operating your freezer

#### Super Freeze Mode

##### Purpose

- To freeze a large quantity of food that cannot fit on the fast freeze shelf.
- To freeze prepared foods.
- To freeze fresh food quickly to retain freshness.

##### How to use

- Press the decreasing button (#7 on control panel diagram) repeatedly until the 'Super Freeze logo appears' (#2).
- Once the Super Freeze mode has been set, the machine will beep to confirm the mode has been switched on.
- After the beep the original temperature of the freezer will appear on screen.
- Mode can be cancelled by repeating the above instructions from the beginning.



##### During this mode:

- Economy mode cannot be selected whilst Super Freeze is active.

#### Economy Mode

##### Purpose

Energy savings. During periods of less frequent use (door opening) or absence from home, such as a holiday, Eco program can provide optimum temperature whilst saving power.

##### How to Use

- Press mode selector (M) (#6 on control panel diagram) until the 'Eco Mode' icon (leaf) appears (#3).
- Once the 'Eco mode' has been set, the machine will beep to confirm the mode has been switched on.
- After the beep the freezer temperature setting (#1) will display an 'E'.
- Eco Mode can be cancelled by pressing the M button (#6).



##### During this mode:

- The freezer temperature may be adjusted however the adjustment will not be made until Eco Mode is cancelled. When economy mode is cancelled, the selected setting value will be activated and the temperature will be adjusted.
- Super Freeze mode can be selected, however by selecting mode Eco Mode is cancelled immediately.

## CHAPTER -3: USING YOUR FREEZER

### Screen Saver Mode

#### Purpose

This mode saves energy by switching off all control panel lighting when the panel is left inactive.

#### How to Use

- Screen saver mode will be activated automatically after 30 seconds.
- If you press any key while the lighting of the control panel is off, the current machine settings will reappear on the display to let you make any change you wish.
- If you do not cancel the screen saving mode or press any key for 30 seconds, control panel will remain off.



#### To deactivate the screen saving mode,

- To cancel the screen saving mode, first of all, you need to press any key to activate the keys and then press and hold the Mode button "M" (#6) for 3 seconds.
- To reactivate screen saving mode, press and hold the mode button "M" (#6) for 3 seconds.

### The Child Lock Function

#### Purpose

Child lock can be activated to prevent any accidental or unintentional changes being made to the appliance settings.

#### Activating Child Lock

Press and hold child lock button  (#9) for 5 seconds.

#### Cancelling Child Lock

Press and child lock button  (#9) for 5 seconds.

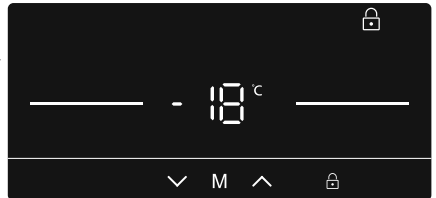

### Door Open Alarm Function

If freezer door is left open for more than 2 minutes, the appliance will beep.

### Freezer Temperature Settings

- Users can use the decreasing or increasing button (#7 / #8) to set the temperature (-16, -17, -18, -19, -20, -21, -22, -23, -24°C and Super Freeze Mode "super").
- If Super Freeze mode or Eco mode is activated, the temperature will not change until the mode is cancelled.



#### Recommended Temperature Values for Freezer

When to adjust	Inner Temperature (°C)
For minimum freezing capacity	-16°C, -17°C
In normal usage	-18°C, -19°C, -20°C, -21°C
For maximum freezing capacity.	-22°C, -23°C, -24°C

### Warnings for temperature settings

- The ambient temperature, temperature of the freshly stored food and how often the door is opened, affects the temperature in the freezer. If required, change the temperature setting.
- It is not recommended that you operate your freezer in environments colder than 10°C.
- The temperature setting should be set by taking into consideration how often the freezer door is opened and closed, how much food is stored in the freezer and the environment in which and the positioning of the appliance.
- We recommend that when first using the freezer it should be left running for 24 hours uninterrupted to ensure it is completely cooled. Do not open the freezer door, or put food inside for this period.
- Your freezer has a 5 minute built in delay function, designed to prevent damage to the compressor. When power is applied to your freezer, it will begin to operate normally after 5 minutes.
- Your freezer is designed to operate in the ambient temperature intervals stated in the standards, according to the climate class stated in the information label. It is not recommended that your freezer is operated in the environments which are out of the stated temperature intervals in terms of cooling efficiency.

## CHAPTER -3: USING YOUR FREEZER

- This appliance is designed for use at an ambient temperature within the 10°C - 43°C range.

Climate Class	Ambient Temperature °C
T	Between 16 and 43 (°C)
ST	Between 16 and 38 (°C)
N	Between 16 and 32 (°C)
SN	Between 10 and 32 (°C)

### Accessories

#### Icematic (In some models)

- Take out the ice making tray
- Fill the water to the line.
- Place the ice making tray in its original position
- When ice cubes are formed, twist the lever to drop ice cubes into the icebox.

#### Note:

- Do not fill the icebox with water in order to make ice. It may be broken.
- The movement of the ice maker may be difficult while the refrigerator is running. In such a case, it should be cleaned after removing the glass shelves.

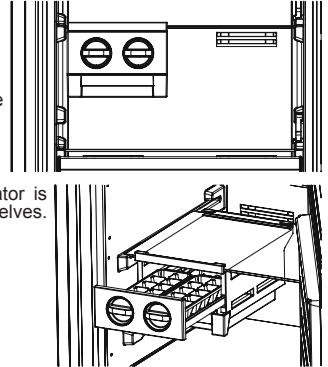

#### Ice tray (In some models)

- Fill the ice tray with water and place in freezer compartment.
- After the water completely turned into ice, you can twist the tray as shown below to get the ice cube.

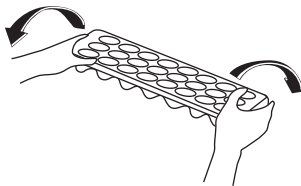
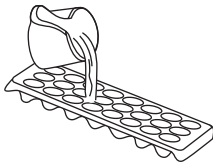

### Cleaning

- **Before cleaning your freezer, turn your mains supply off and remove the plug from the socket.**
- Do not wash your freezer by pouring water on to it.
- Use a warm, soapy cloth or sponge to wipe the interior and exterior of your freezer.
- Carefully remove all baskets by sliding upwards or outwards and clean with soapy water. Do not wash in a washing machine or dishwasher.
- Do not use solvents, abrasive cleaners, glass cleaners or all purpose cleaning agents to clean your freezer. This may cause damage to the plastic surfaces and other components with the chemicals they contain.
- Clean the condenser at the back of your freezer at least once a year with a soft brush or vacuum cleaner.

**Make sure that your freezer is unplugged while cleaning.**

#### Replacing LED Lighting

If your fridge freezer has LED lighting contact the Sharp help desk as this should be changed by authorized personnel only.

## CHAPTER -3: USING YOUR FREEZER

### Defrosting

Your freezer automatically defrosts. The water formed as a result of defrosting passes through the water collection spout, flows into the vaporization container behind your freezer and evaporates by itself in there.

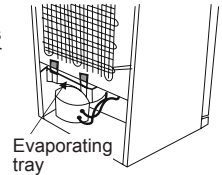

## CHAPTER -4: FOOD STORAGE GUIDANCE

- Use the freezer to store frozen foods for long periods of time and make ice cubes.
- **'Maximum load:** if you want to store large quantities of food and use the maximum net capacity of the freezer, you can remove all the sliding drawers but you may keep the freezer flaps. Thanks to this, it is possible to store bulky items directly on the shelves.'
- Do not put fresh food on either side of frozen food as it can thaw it.
- While freezing fresh foods (i.e meat, fish and mincemeat), divide into portion sizes.
- Once the unit has been defrosted replace the foods into freezer and remember to consume them in a short period of time.
- Never place warm food in the freezer compartment.
- The instructions shown on frozen food packages should always be followed carefully and if no information is provided food should not be stored for more than 3 months from the purchased date.
- When buying frozen foods ensure that these have been frozen at suitable temperatures and that the packing is intact.
- Frozen foods should be transported in appropriate containers to maintain the quality of the food and should be stored in the freezer as soon as possible.
- If a package of frozen food shows signs of humidity and abnormal swelling it has been previously stored at an unsuitable temperature and that the contents have deteriorated.
- The storage life of frozen foods depends on the room temperature, thermostat setting, how often the door is opened, the type of food and the length of time required to transport the product from the shop to your home. Always follow the instructions printed on the package and never exceed the maximum storage life indicated.

**That;** If you decide to open the freezer door again immediately after closing, it may be difficult to re-open. This is normal and after the freezer has reached an equilibrium condition the door will open easily.

### Important note:

- *Frozen foods, when thawed, should be cooked just like fresh foods. If they are not cooked after being thawed they must NEVER be re-frozen.*
- The taste of some spices found in cooked dishes (anise, basilica, watercress, vinegar, assorted spices, ginger, garlic, onion, mustard, thyme, marjoram, black pepper, etc.) changes and they assume a strong taste when they are stored for a long period. Therefore, only add a small amount of spice if planning to freeze, or the desired spice should be added after the food has been thawed.
- The storage period of food is dependent on the oil used. The suitable oils are margarine, calf fat, olive oil and butter and the unsuitable oils are peanut oil and pig fat.
- The food in liquid form should be frozen in plastic cups and the other food should be frozen in plastic folios or bags.

## CHAPTER -5: DOOR REVERSAL

### Repositioning the door

- It depends on which freezer you have as to whether it is possible to reverse the door.
- It is not possible where handles are attached at the front of the appliance.
- If your model does not have handles it is possible to reverse the doors, but this needs to be completed by authorised personnel. Please call Sharp service.

## CHAPTER -6: TROUBLESHOOTING

Your Freezer is equipped with a built in fault detection system, which is able to give you guidance should your freezer not operate as expected. In the event of an error code will be displayed on the control panel. The most common error codes are shown below. If your freezer displays a code not shown below contact the Sharp help-desk.

ERROR TYPE	MEANING	WHY	WHAT TO DO
E01	Sensor warning		Contact the Sharp help desk as soon as possible.
E02	Sensor warning		Contact the Sharp help desk as soon as possible.
E03	Sensor warning		Contact the Sharp help desk as soon as possible.
E06	Sensor warning		Contact the Sharp help desk as soon as possible.
E07	Sensor warning		Contact the Sharp help desk as soon as possible.
E08	Low Voltage Warning	Power supply to the device has dropped to below 170W.	<ul style="list-style-type: none"> <li>- This is not a device failure, this error helps to prevent damages to the compressor.</li> <li>- The voltage needs to be increased back to required levels</li> </ul> <p>If this warning continues, contact the Sharp help desk as soon as possible.</p>
E09	Freezer compartment is not cold enough	Likely to occur after long term power failure.	<ol style="list-style-type: none"> <li>1. Set the freezer temperature to a colder value or set Super Freeze. This should remove the error code once the required temperature has been reached. Keep doors closed to improve time taken to reach the correct temperature.</li> <li>2. Remove any products which have thawed/defrosted during this error. They can be used within a short period of time.</li> <li>3. Do not add any fresh produce to the freezer compartment until the correct temperature has been reached and the error is no longer.</li> </ol> <p>If this warning continues, contact the Sharp help desk as soon as possible.</p>

### Check Warnings;

#### If your freezer is not operating;

- Is there a power failure?
- Is the plug connected to the socket correctly?
- Is the fuse of the socket to which the plug is connected or the main fuse blown?
- Is there any failure at the socket? To check this, plug your refrigerator into a known working socket.

#### If your freezer is not cooling enough;

- Is the temperature adjustment right?
- Is the door of your freezer opened frequently and left open for a long while?
- Is the door of freezer closed properly?
- Did you put a dish or food on your freezer so that it contacts the rear wall of your freezer so as to prevent the air circulation?
- Is your freezer filled excessively?
- Is there adequate distance between your freezer and the rear and side walls?
- Is the ambient temperature within the range of values specified in the operating manual?

## CHAPTER -6: TROUBLESHOOTING

### If the food in your freezer is over cooled

- Is the temperature adjustment right?
- Are there many food recently put inside the freezer?

### If your freezer is operating too loudly;

To maintain the set cooling level, compressor may be activated from time to time. Noises from your freezer at this time are normal and due to its function. When the required cooling level is reached, noises will be decreased automatically. If the noises persist;

- Is your appliance stable? Are the legs adjusted?
- Is there anything behind your freezer?
- Are the shelves or dishes on the shelves vibrating? Re-place the shelves and/or dishes if this is the case.
- Are the items placed on your freezer vibrating?

### Normal Noises;

#### Cracking (Ice cracking) Noise:

- During automatic defrosting.
- When the appliance is cooled or warmed (due to expansion of appliance material).

**Short cracking:** Heard when the thermostat switches the compressor on/off.

**Compressor noise (Normal motor noise):** This noise means that the compressor operates normally Compressor may cause more noise for a short time when it is activated.

**Bubbling noise and splash:** This noise is caused by the flow of the refrigerant in the tubes of the system.

**Water flow noise:** Normal flow noise of water flowing to the evaporation container during defrosting. This noise can be heard during defrosting.

**Air Blowing Noise (Normal fan noise):** This noise can be heard in No-Frost freezer during normal operation of the system due to the circulation of air.

### If humidity builds up inside the freezer;

- Has the food been properly packaged? Have the containers been well dried before they were put into the freezer?
- Is the door of the freezer opened very frequently? When the door is opened, the humidity found in the air in the room enters the freezer. Especially if the humidity rate in the room is too high, the more frequently the door is opened the faster will be the humidification.

### If the doors are not opened and closed properly;

- Do the food packages prevent closing of the door?
- Are the door freezer, baskets and Ice box placed properly?
- Is door gasket broken or torn?
- Is your freezer on a level surface?

### If the edges of freezer cabinet that the door joint contact are warm;

Especially in summer (hot weather), the surfaces that the joint contact may get warmer during the operation of the compressor, this is normal.

### IMPORTANT NOTES:

- The compressor protection thermal fuse will cut out after sudden power breakdowns or after unplugging the appliance, because the gas in the cooling system is not stabilised. This is quite normal, and the freezer will restart after 4 or 5 minutes.
- The cooling unit of your freezer is hidden in the rear wall. Therefore, water droplets or ice may occur on the rear surface of your freezer due to the operation of the compressor in specified intervals. This is normal. There is no need to perform a defrosting operation unless the ice is excessive.
- If you will not use your freezer for a long time (e.g. in summer holidays) unplug it. Clean your freezer according to Part 4 and leave the door open to prevent humidity and smell.
- The appliance you have purchased is designed for home type use and can be used only at home and for the stated purposes. It is not suitable for commercial or common use, if the consumer uses the appliance in a way that does not comply with these features, we emphasise that the producer and the dealer shall not be responsible for any repair and failure within the guarantee period.
- If the problem persists after you have followed all the instructions above, please consult an authorised service provider.

## CHAPTER -7: TIPS FOR SAVING ENERGY

- Do not install the appliance close to heat producing appliances. Such as cooker, oven, dishwasher or radiator, and locate the appliance in the coolest part of the room.
- locate the appliance in a cool well ventilated room and make sure that the air openings of the appliances are not obstructed.
- Always leave warm food to cool down to room temperature before placing in the freezer.
- Try to avoid keeping the door open for long periods or opening the door too frequently as warm air will enter the cabinet and cause the compressor to switch on unnecessarily often.
- Ensure there are no obstructions preventing the door from closing properly.
- Cover foods before placing them in the freezer. This cuts down on moisture build-up inside the unit.
- Refer to the "temperature settings" section for the suggested temperature control settings.
- Do not block cold air vents. Doing so causes the freezer to run longer and use more energy.
- Keep freezer full.
- Level the freezer so that the door closes tightly.
- Occasionally clean the rear of the appliance with a vacuum cleaner or paint brush to prevent an increased power consumption.
- Keep door gaskets clean and pliable. Replace gaskets if worn.

## CHAPTER -8: SERVICE & WARRANTY

If you are unable to resolve a problem using the checks covered in the last few pages, do not attempt to service this fridge freezer yourself.

In the unlikely event of the product requiring repair, please contact the Customer Support Centre. Telephone: 0333 577 7230 Lines are open Mon to Fri 09.00 to 20.00 & Sat and Sun 10.00 to 16.00

Vestel UK the licence partner for Sharp guarantees that for a period of 2 years from the date of purchase the enclosed product will be free from defects in materials and workmanship. Vestel UK agrees to provide for the repair or, at its option, the replacement of a defective product. Vestel UK reserves the right to replace defective parts, or the product, with new or refurbished items. Items that are replaced become the property of Vestel UK. To benefit from this guarantee, any fault that occurs must be notified to Vestel UK, or its appointed Service Facility, within two years from the date the product was purchased. Proof of purchase, such as a receipt or invoice, must be provided. If the product is exchanged, the replacement shall be covered by the unexpired portion of the original guarantee.

This guarantee shall only apply to faults that are due to an electrical or mechanical breakdown. It does not cover faults or damage caused by accident, misuse, fair wear and tear, neglect, tampering with the product, or repair other than by a Service Facility appointed by Vestel UK.

The product is intended for private domestic use only. The guarantee will not apply if the product is used in the course of a business, trade or profession.





**Service  
& Support**

Visit our website:  
[www.sharphomeappliances.com](http://www.sharphomeappliances.com)

Or contact us:

